



DATA RETENTION SOLUTIONS FOR THE COMMUNICATION INDUSTRY

HPE DRAGON

Your organization needs a secure and fully integrated approach to fulfill lawful enforcement requests and their related handshake with the legal authorities. With HPE DRAGON solutions—comprising a complete, end-to-end offering for warrant management, lawful intercept, and data retention, you get actionable intelligence for your global law enforcement efforts.

ENSURE TECHNOLOGY SUPPORTS GLOBAL LAW ENFORCEMENT EFFORTS

Communications technology is at the heart of the global fight against terrorism, child exploitation, drug trafficking, and other serious crimes. Law enforcement is asking more of service providers—greater cooperation and expanded capabilities. This requires lawful requests—communications information to support criminal investigations—be fulfilled in a timely manner. As a service provider, you need a cost-effective way to manage these requests; to quickly identify, locate, and retrieve data on user activity history; intercept content in real-time; and deliver it securely to authorities.

Complicating the challenge are new technologies, equipment, and user devices being developed and deployed throughout the communications ecosystem. Where in-house solutions were once adequate, a comprehensive set of integrated capabilities is now required. Standards-based, proven solutions are needed to mitigate the risks, timeframes, and costs of adding critical functionality.

USE PROVEN TOOLS FOR INTELLIGENCE SUPPORT AND DATA RETENTION

HPE delivers a comprehensive portfolio of intelligence support systems (ISSs) that meet the requirements for today’s converged communications services. Based on technology proven in worldwide deployments, HPE Data Retention And Guardian Online (DRAGON) solutions are modular and standards-based and take a fully integrated, real-time approach to fulfill regulatory compliance in Lawful Interception and Data Retention for communications records.

Together, they comprise a complete, end-to-end offering for warrant management, lawful intercept, and data retention—providing actionable intelligence for today’s global law enforcement efforts.

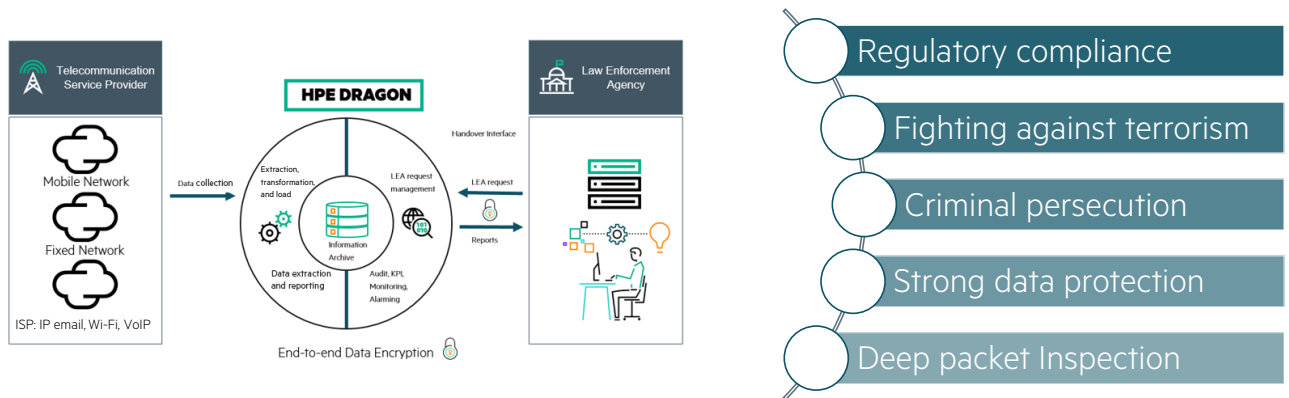

FIGURE 1. HPE DRAGON solutions portfolio

TABLE 1. The HPE Investigation portfolio addresses the special challenges of six critical areas

Solution name	Brief description
1. Data Retention	Innovative capture and management of communications activity data
2. Warrant/Request management	Process-driven reengineering of warrant handling to improve cycle time and reducing the total cost of ownership
3. Lawful Interception and Law Enforcement Agency monitoring and analysis	Innovative lawful interception capabilities for IP services and next-generation networks (*with HPE partner)
4. Large Event Archive	A highly scalable and flexible solution that eases access to critical operations data
5. Deep Packet Inspection	Network probes collect more detailed network traffic data in real-time (**with HPE OEM partner)
6. ISS as a Service/Cloud	Flexibility, low cost, and easy implementation offered



HPE Data Retention benefits

- Reduces data retention operating expenses
- More efficiently gathers data to respond to warrants and requests
- Complies with local regulation

HPE adds value

- Market-leading data retention solution
- 25+ years of experience
- Process, system, and data review service assessment
- Warrant management engine
- Modular and built on a common architecture including Hadoop ecosystem
- On-premises, on cloud, and on hybrid set-up option

HPE Warrant/Request management benefits

- More flexible, efficient way to gather customer data and respond to LEA warrants and requests
- Legal compliance

HPE adds value

- Warrant workflow engine
- Process, system, and data review service assessment
- Software brokering capabilities
- Automated interface with the lawful enforcement authorities

MANAGE DATA RETENTION

New regulations for retaining data records are greatly expanding what information is kept and its lifecycle. This can present a burden for service providers, who must deal with issues of data collection, and also efficient and secure storage and retrieval. Today's next-generation converged environments expose the limitations and inadequacies of legacy systems. The rapid adoption of network-intensive services means you have to process several times the volume of records. Immense scalability and cost-effective storage and retrieval are crucial. Further, the shifting services environment and regulatory landscape require a solution that can easily adapt.

HPE DRAGON Data Retention

- Provides scalable, flexible data collection for circuit- and packet-switched infrastructures
- Uses high-performance data management to optimize storage and retrieval of communications traffic data
- Leverages multilayer security to protect the integrity and privacy of sensitive data
- Can be implemented with a choice of data repository options to ease integration with existing architectures and technology standards

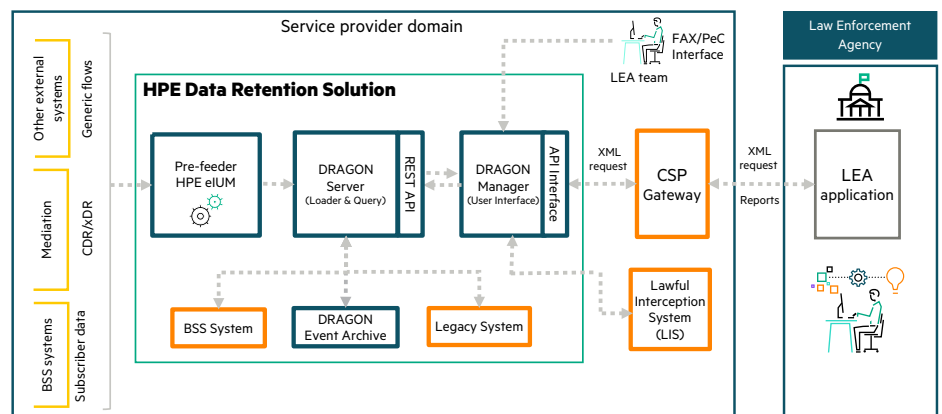

FIGURE 2. HPE DRAGON architecture overview

MANAGE WARRANTS REQUESTS

An increasing volume of requests for lawfully intercepted and retained data comes from a range of law enforcement agencies (LEAs). Key issues are involved in efficiently and effectively fulfilling these requests while ensuring privacy at every point—provisioning, result validation, and returning results to the LEA. With some service providers—fulfilling thousands of time-intensive requests each day—improved efficiency directly translates to the bottom line. Over time, many service providers deployed individual ISSs for each service area. In many cases, requests were input for each system or service area, results manually aggregated and then returned to the LEA. Consolidation and integration may cut operating costs and shorten response time, while helping safeguard privacy.



HPE Lawful Interception benefits

- Complies with LEAs' requirements
- Can upgrade capabilities to IP services
- Consolidates lawful interception (LI) vendors

HPE adds value

- Single frontend software for different LI infrastructures
- Process, system, and data review service assessment
- Integrated ISS approach—Legal Investigation plus Data Retention

HPE Warrant/Request management features:

- A single, unified frontend manages request fulfillment for lawful intercept and retrieval of retained data.
- Increased workflows reduce the effort and timeframes for processing requests.
- Flexible deployment models enable localized deployment at CSPs, or remote deployment for self-service operations at law enforcement and intelligence agencies.
- Document management capabilities support warrant and request documentation.
- A billing export function supports reimbursement of compensated requests.

- The workflow is based on the process commonly started when the LEA asks for customer or traffic data information.
- DRAGON Manager console provides single, uniform access to a set of disparate data repositories that is a natively an complex task, especially if access to the data is restricted depending on privileges.

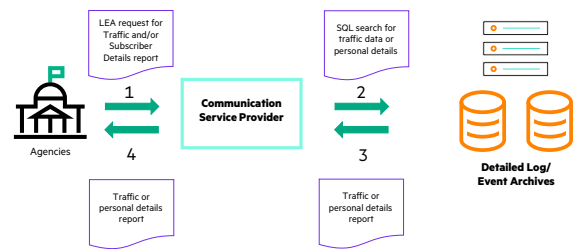

FIGURE 3. HPE DRAGON Manager workflow overview

HPE Large Event Archive benefits

- Provides the right archive technology for different data needs
- Reduces CAPEX and OPEX
- Offers the solution in the cloud

HPE adds value

- Faster data loaders with embedded encryption for security compliance and data partitioning for query performance and data retention lifecycle
- DRAGON application security across the entire archive
- Replica and compression factor
- System integration capabilities

INCORPORATE LAWFUL INTERCEPTION

While seamless interception has long been available for analog circuit-switched networks, the evolution to advanced services running across packet-switched infrastructures now requires new technologies. Interception must be performed—in real-time—across wireless, wired, broadband, and internet protocol (IP) networks, while still remaining invisible to parties under surveillance.

Interception of new network-intensive applications such as email and instant messaging requires application awareness and also immense scalability and flexibility. As more and more services are deployed via IP networks, the challenge will grow in volume and complexity.

The HPE Lawful Interception solution:

- Supports disparate, multiple communication networks—circuit switched, packet switched, mobile, fixed, and IP
- Includes support for products from most major vendors
- Supports global standards with customizable local implementations
- Enables cost-effective expansion of architecture with a distributed, scalable solution



HPE DPI benefits

- Advantages of network-based monitoring versus log-based monitoring
- Real-time data capture
- Data filtering

HPE adds value

- End-to-end solution for data collection
- DPI integrates with Data Retention, Lawful Interception, and Warrant management solutions

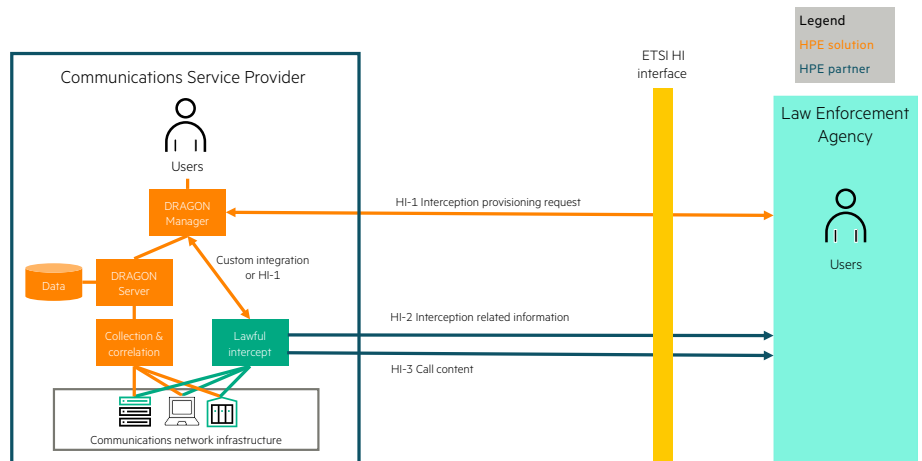

FIGURE 4. HPE DRAGON and LI integration

MANAGE LARGE EVENT ARCHIVE

Every day, companies must store and manage a large amount of information, used for purposes ranging from marketing to billing capacity, planning, legal, and compliance. Such large data archive requirements are properly addressed by our HPE offering. Data is becoming one of the biggest corporate topics: Data management is no longer an IT problem, but a one of corporate strategy.

Moreover, different data needs different archival, retrieval, and security capabilities. They can be heterogeneous a mix of text and binary, for instance. Sensitive data need strong security and end-to-end encryption.

HPE Large Event Archive features:

- A solution technology based on the proven HPE DRAGON Data Retention architecture and experiences to deliver a data repository solution for all data types
- Scalability and flexibility offer easy access to critical operations data
- Enhanced data compression reduces storage size
- Capability to collect logs
- High performance throughput up to 100 Billion event per day leveraging both DRAGON application and Hadoop Cluster
- High performance on query response time observed:
 - 300 requests with a search period of 120 days completed in 1 hour
 - 10 complex requests in less than 10 minutes



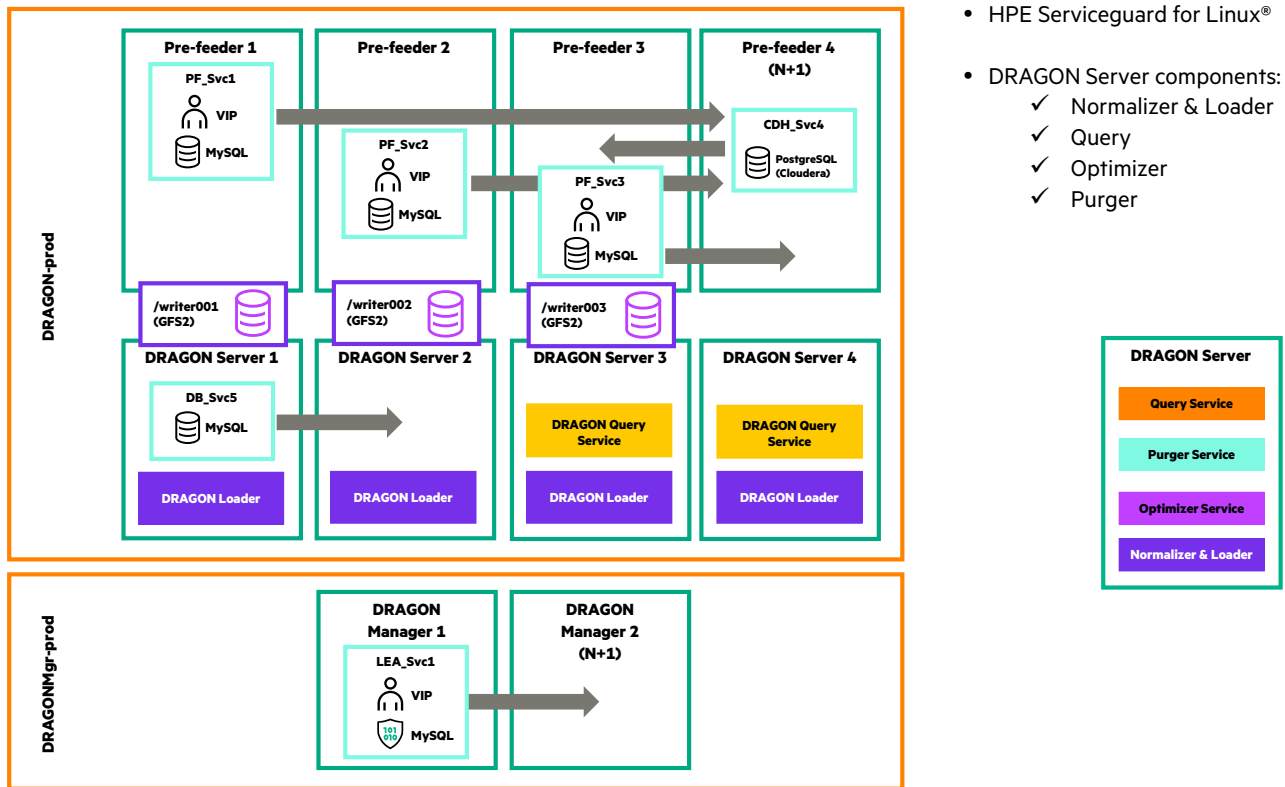

FIGURE 5. HPE DRAGON components and HA clustering architecture

INCORPORATE DEEP PACKET INSPECTION

Deep Packet Inspection (DPI) is a relevant tool in telecommunications and the ISS sector. It enables real-time data collection and offers the ability to filter out unnecessary data. HPE DRAGON solutions are improved by DPI data collection mechanisms, as the DPI solution can be integrated with the Data Retention, Lawful Intercept, and Warrant/Request management solution, or it can be deployed in the ISS-as-a-Cloud solution. The DPI solution features:

- Accurate user identification across multiple applications, physical locations, terminals, and identities
- Extraction of relevant data to enhance storage space and speed up post processing
- Implementation of real-time, network-based monitoring using probes



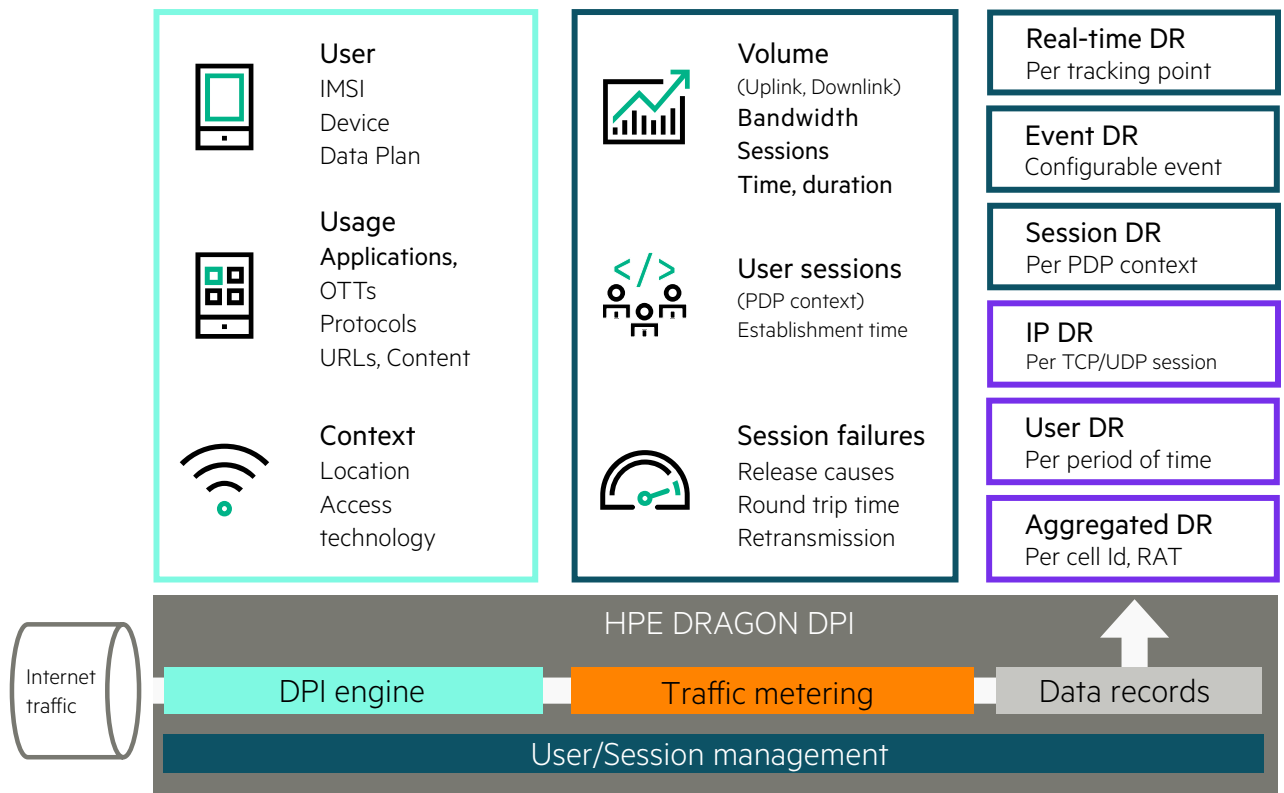

FIGURE 6. HPE DRAGON DPI: Extract the right info from data traffic in real-time

COMPLY USING ISS AS A SERVICE/CLOUD

HPE ISS as a Service/Cloud provides all the features of Data Retention, Warrant/Request management, and Lawful Interception solutions in a hosted or centralized virtual environment. It provides easy implementation—one of the advantages of cloud solutions; and it requires less up-front investment, resulting in a good choice for small- and medium-sized communications service providers (CSPs). The solution complies with regulations, and further changes can be easily adopted.

ISS as a Service/Cloud solution features:

- A solution customized by the CSP or government requirement.
- Flexible approaches—“broker” or central solution can be implemented.
- A hosted intelligence support solution for small- and medium-sized operators.
- An integrated ISS solution to improve information flow and reduce complexity.



HPE ISS as a Service/Cloud benefits

- Flexible, easy-to-deploy ISS solution
- Minor investment for ISS
- Compliance with local regulations

HPE adds value

- End-to-end ISS solution for Data Retention, Lawful Interception, Warrant management, and several enhancements
- 25+ years of experience

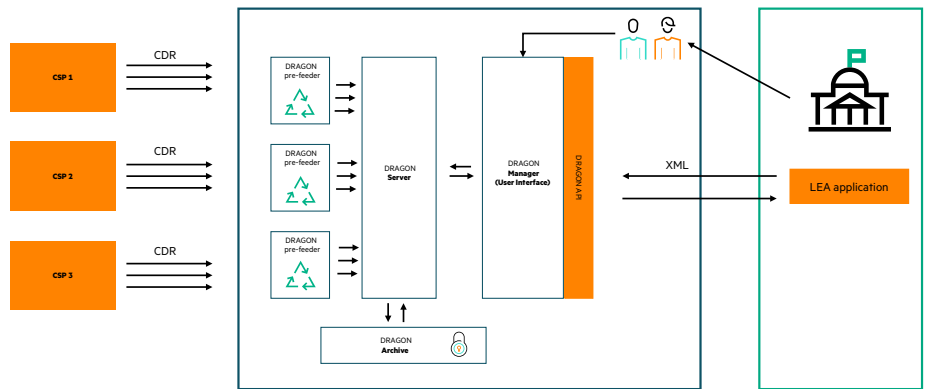

FIGURE 7. HPE DRAGON suite—centralized architecture

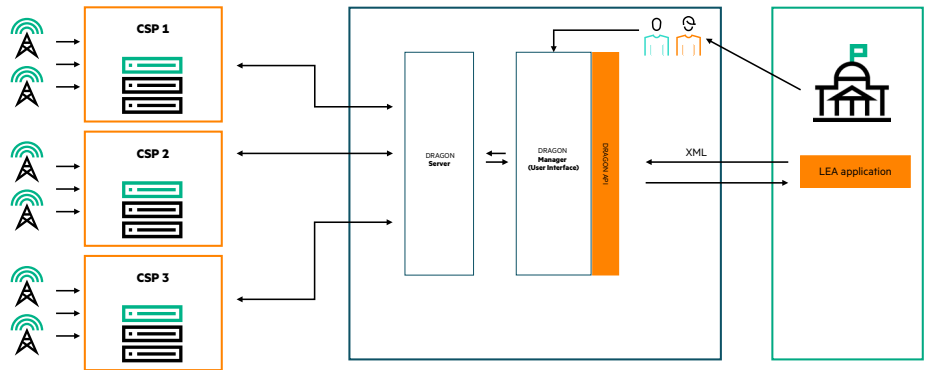

FIGURE 8. HPE DRAGON suite—distributed architecture

REVIEW THE PLATFORM—DRAGON

Flexible HPE DRAGON supports many business models, including mobile virtual network operator (MVNO); hosted, multiple operating units; and multiple geographies. The latest DRAGON version—DRAGON—addresses the challenges of integration and security with proven technologies and methodologies.

New product features in DRAGON

- Solution for repositories, Large Event Archive
- Solution for ISS as a Service/Cloud

Integration

- Supports all common integration standards and technologies, including ETSI, CALEA, 3GPP, web services, and XML
- Reduces operating costs through a common integration approach for external and internal systems



Security

- Provides comprehensive data security features, including encryption and certificates that protect privacy and integrity
- Includes robust user security mechanisms, such as user access controls, auditing and reporting, and optional integration with external authentication systems
- Provides secure messaging channels

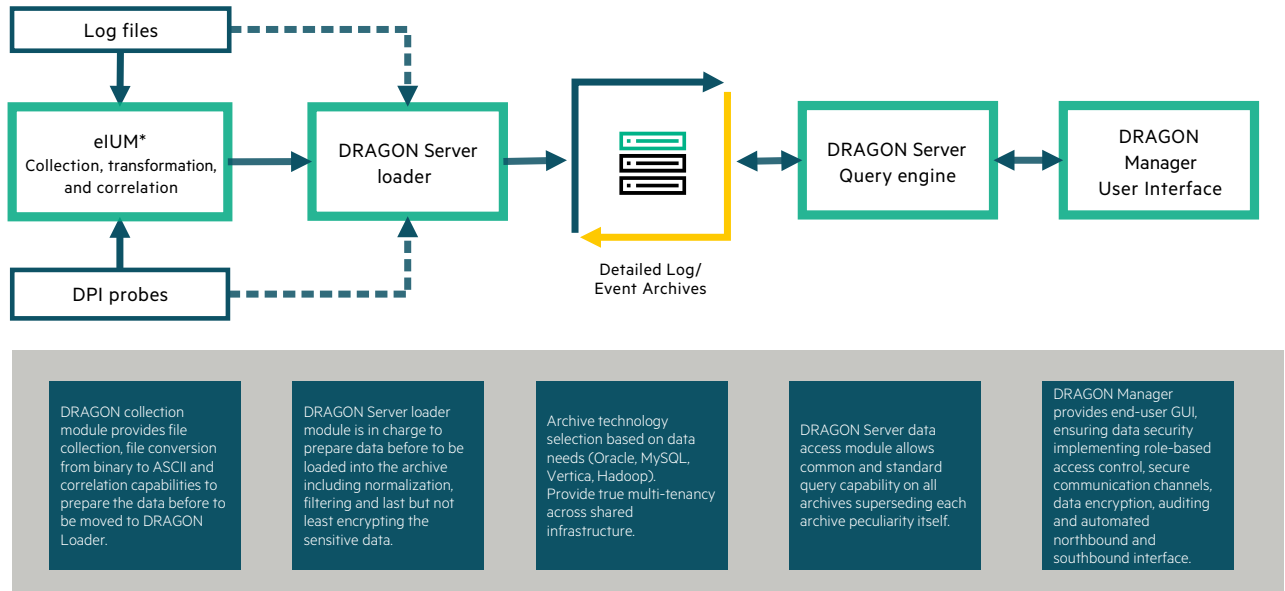

FIGURE 9. HPE DRAGON high-level architecture

HPE VALUE PROPOSITION

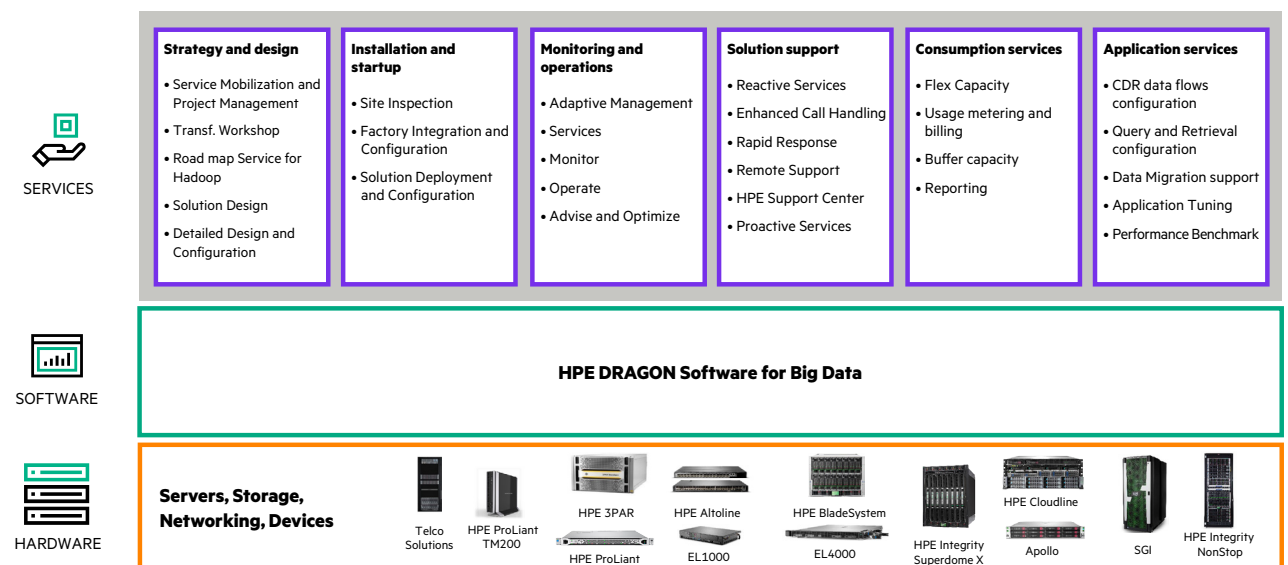

FIGURE 10. HPE value proposition

* HPE enhanced Internet Usage Manager (eIUM)



USE PROVEN TOOLS FOR INTELLIGENCE SUPPORT AND DATA RETENTION

Hewlett Packard Enterprise delivers a comprehensive portfolio of intelligence support systems that meet the requirements for today's converged communications services. Based on technology proven in worldwide deployments, HPE Data Retention And Guardian Online solutions are modular and standards-based and take a fully integrated, real-time approach to fulfilling lawful requests for data. Together, they comprise a complete, end-to-end offering for warrant management, lawful intercept, and data retention—providing actionable intelligence for today's global law enforcement efforts.

Fully featured technology

Recognized leadership in Telco deployments with more than 30 worldwide deployments



Modular and built on a common architecture including Hadoop ecosystem



Proven lower TCO replacing several in house solutions



Highly scalable—up to hundreds of billions events per day (Petabytes)



Solutions built on open-standards, offering choice and flexibility



Out-of-the-box solutions

Purpose-built to enable CSP legal compliance and obligation



Leading capabilities

25 years of proven, worldwide legal compliance experience



Seamless integration within portfolio



End-to-end solutions from Data Retention up to DPI



FIGURE 11. HPE DRAGON key features

GET THE SOLUTION YOU NEED

Regardless of law enforcement's request, you need the ability to quickly identify, locate, and provide data in a timely manner. With HPE DRAGON, it can be done.

LEARN MORE AT

hpe.com/dsp/transform

Make the right purchase decision.
Contact our presales specialists.



Chat



Email



Call



Get updates